

IMPORTANT NOTE:
Use these instructions for **MODEL D** assembly.

MODEL D

Weight: 57 lb (26 kg)
Dimensions: 8 ft x 2 ft (244 cm x 61 cm)
Space Required for Use: 9 ft x 4 ft (274 cm x 122 cm)
Weight Capacity: 500 lb (227 kg) as tested by Concept2*
*300 lb (135 kg) as tested per European Stationary Fitness Equipment Testing Standard EN 20957-7

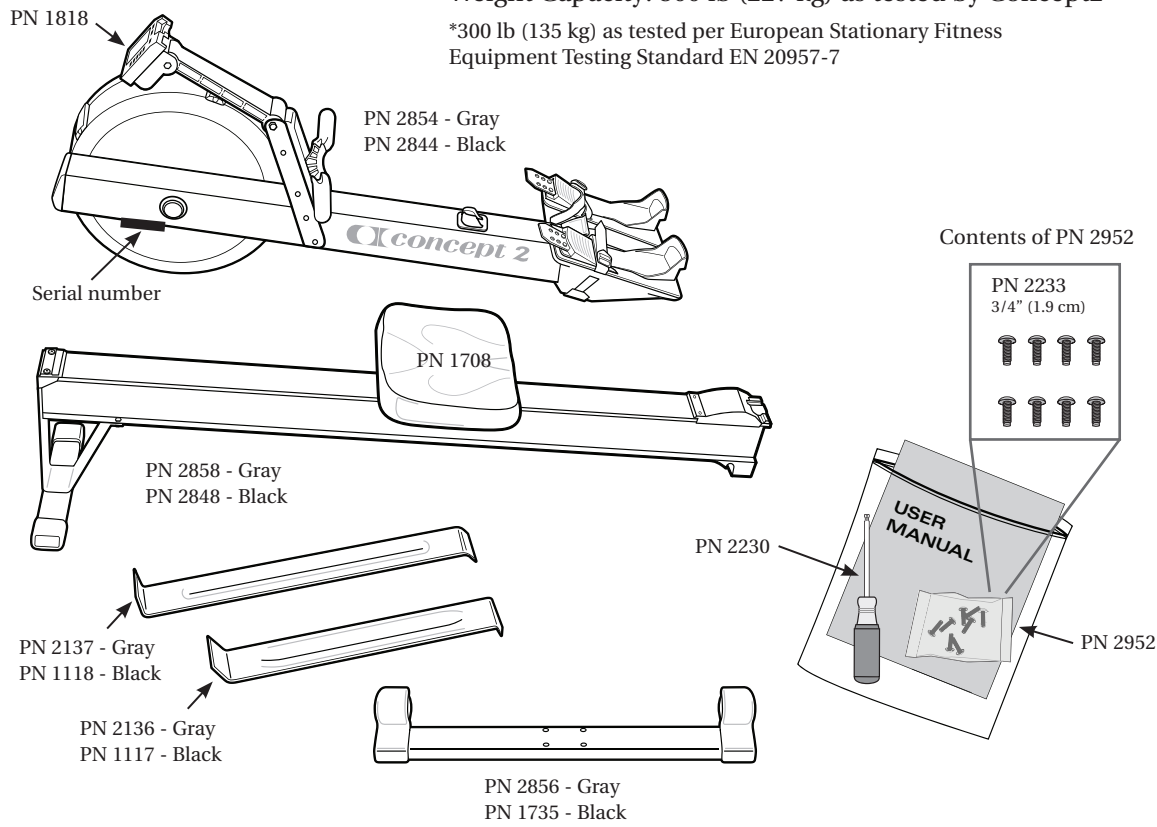

3

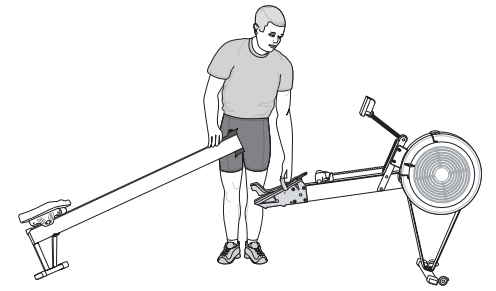

1.

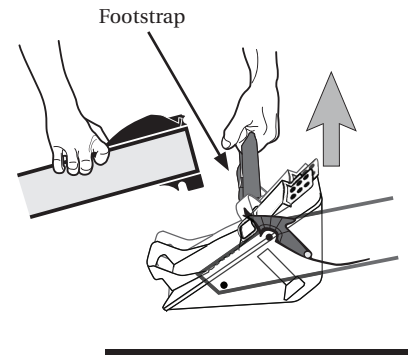

2.

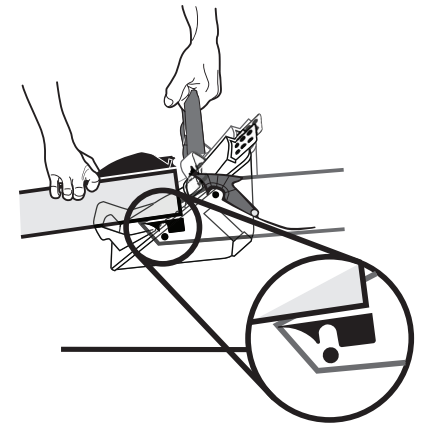

3.

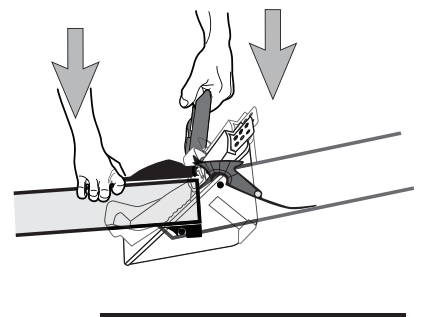

4.

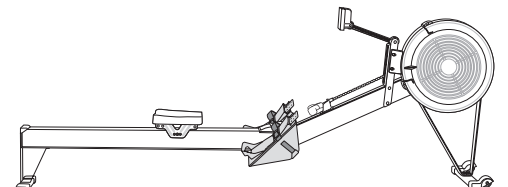
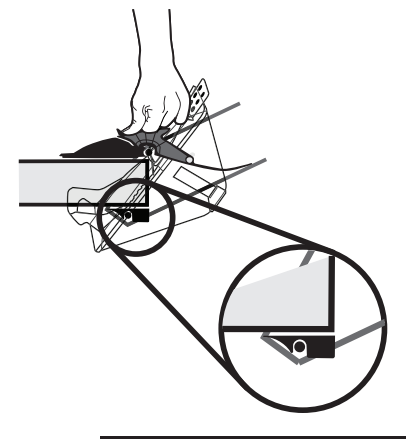

1

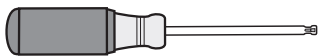

(4) 3/4" (1.9 cm)
PN 2233

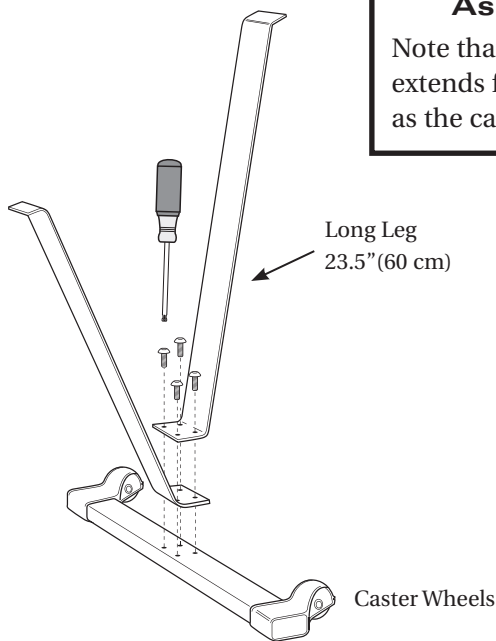

Assembly Tip

Note that the long leg extends from the same side as the caster wheels.

2

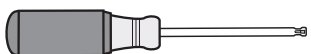

(4) 3/4" (1.9 cm)
PN 2233

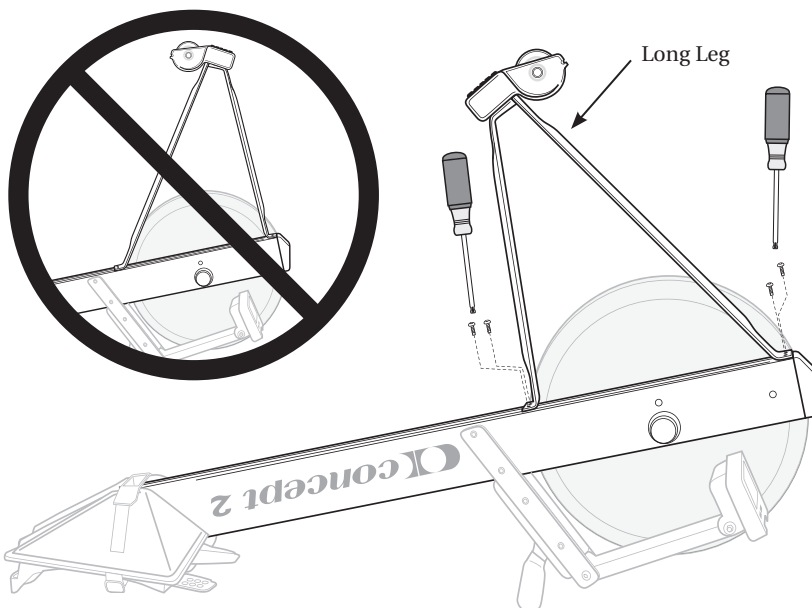

Assembly Tip

To prevent thread damage, be sure holes line up before inserting fasteners. Do not fully tighten until all fasteners are in place.